

SIDING INSTRUCTIONS

THE LOOK OF WOOD OR VINYL WITH THE DURABILITY OF STEEL



**METAL ROOFING
SUPPLY**

www.metalroofingsupply.org

INTRODUCTION

- All applications and detailed drawings in this guide are proven methods, but may not be applicable to all building designs. It is the responsibility of the designer, siding contractor and installer to ensure that the following details are adapted to meet the building requirements.
- It is the responsibility of the buyer or installer/contractor to determine the lengths and quantity of materials needed. Field measurements are required prior to ordering material. Quantity of the metal delivered to the job site is based on customer's orders. Metal Roofing Supply is not responsible for customer error.
- Tin snips, a nibble-type electric tool, or band saw can be used for all cutting. *Circular saws will VOID paint warranty due to excessive heat and metal fillings on surfaces.*
- A moisture barrier is recommended. When working with pressure-treated wood, a separation barrier must be used to prevent contact.
- Avoid wet mortar, concrete and stucco as these cementitious materials are alkaline.
- Sealants for flashing shall be non-drying, non-toxic and non-curing. Butyl tapes and sealants are recommended. Sealant joints should be hidden from the sun and weather exposure applied on clean, dry surfaces without skips or voids in the bead.
- Metal Roofing Supply shall be held harmless from any and all claims resulting from a lack of water-tightness as a result of improper installation.

IT IS VERY IMPORTANT FOR THE SIDING CONTRACTOR TO READ AND UNDERSTAND ALL THE POINTS IN THIS MANUAL

GENERAL INFORMATION

Pre-painted steel siding can offer years of trouble-free coverage, but there are a few things you must be knowledgeable of:

- Although most dirt will be washed away by rain, if needed, a mild detergent may be used. You are required to wash the siding twice per year. Before cleaning commences, be sure to look over the area to be washed and insure there will be no harm to the siding.
- *Using any touch-up paint products will VOID the paint warranty.* Touch-up paints will not weather the same as the factory-applied painted steel.

SAFETY

- Follow all OSHA regulations when installing siding.
- Use gloves when handling metal siding and trim as edges are very sharp.
- Be sure to wear the correct gear and equipment. Safety glasses, gloves and hard hats are a must for installers. Safety harnesses may be required when working on multi-level structures.
- Ladders and scaffolding must always be properly secured.
- Never install siding in wet or windy conditions. In windy conditions, workers should never install siding as intense winds during installation can lead to serious injuries.

OIL CANNING

Oil Canning is an inherent characteristic of cold formed metal products and is not a cause for rejection.

- Wall sheathing should be flat with no nails or protrusions. Seams of plywood or OSB deck should be flush.
- Use proper siding fasteners and they should not be overdriven to cause distortions or inhibit movement.
- Carry siding on their side when transporting.

THE LOOK OF WOOD OR VINYL SIDING WITH THE DURABILITY OF STEEL

Metal Roofing Supply offers 3 types of metal siding. Board and Batten, Colonial 5 and Double 5 Dutch. All profiles are a 10" wide coverage.

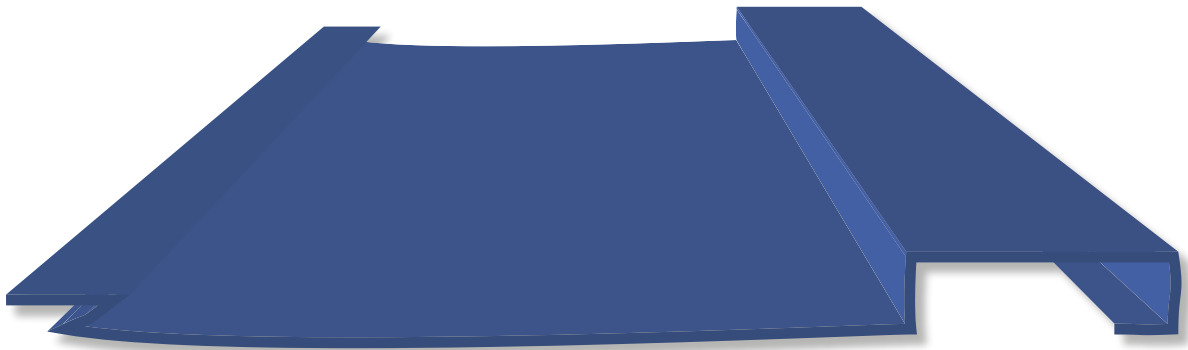

BOARD & BATTEN

Metal Board and Batten give the look of wood boards with metal. With its bold $\frac{3}{4}$ " x 2" batten and 10" coverage, it creates a realistic look of wood without the hassle of painting maintenance. With custom lengths from 1' to 70,' it creates a seamless look with less waste than vinyl.

Panel Specifications:

- The style of wooden siding with the durability of steel
- 45-year limited lifetime warranty
- 10" reveal and a 1/2" deep batten
- Hidden fastener system
- Custom sizing 1' to 70' length
- 26 GA or 28 GA

FASTENING PANELS

When installing Board and batten panels, be sure to use our ultra-low pancake fasteners. Never overtighten fasteners so that the panels are able to move against the substrate. Fasteners must be driven in straight, not at an angle to limit the “oil canning” effect visible within the panels. Metal board and batten should be installed over a minimum 7/16” OSB substrate. Fasteners will need to be installed every 12”.

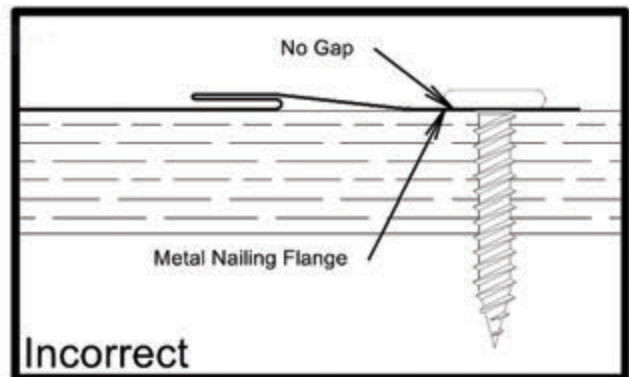
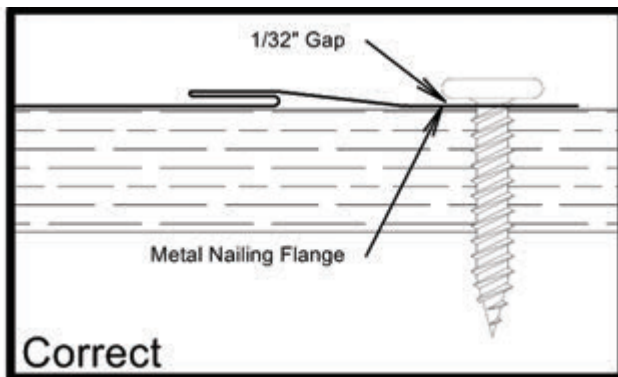

INSTALLING PANELS

Before installing panels be sure to install your base trim (#615), door trim (#610 or #605), window trim (#610 or #605), siding inside corner cleat (#631), siding double j (#600), drip flashing (#660) and top finish strip (#640). When installing Board and batten panels, it is important to always start in the center of your gable ends, and install outwards to the left- and right-hand sides. This will ensure that your rib is in the center of your gable. If you choose to start on one side of the house and work your way over, your battens may not fall to the center of your gable.

INSTALLING PANELS (CONT'D)

To start in the center, follow these 4 steps.

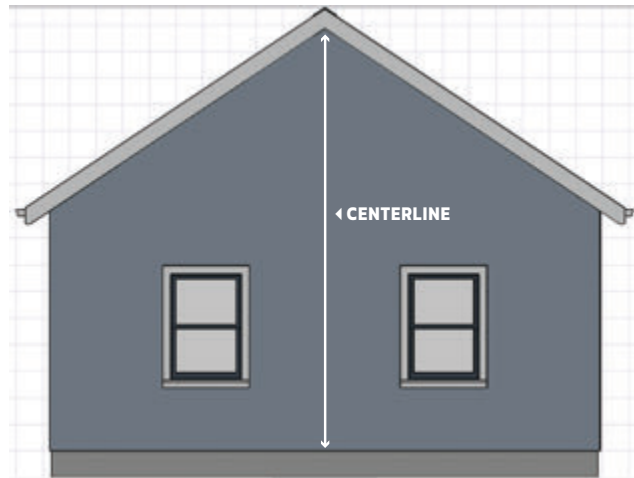

2) Cut the nailing flange portion from a full-length panel.



Install the nail flange with the factory cut side lined up to the left side of the line you made on your gable.

INSTALLING PANELS (CONT'D)

- 3) Cut the batten portion off of a full-length panel.



Fasten the cut piece with the cut end into locking section of your nail flange piece already fastened to the gable as indicated on step 1.



- 4) Fasten a full-length board and batten panel into the nailing flange portion that is holding the cut edge as well. When this is complete you should be able to work in both the left- and right-hand directions.

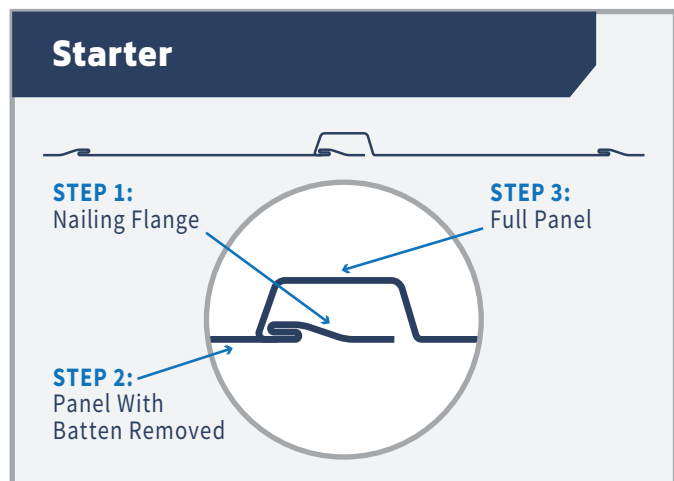

DOOR, WINDOWS AND OTHER OPENINGS

When the panels butt against the side of a window or door opening a siding snap lock (#620 or a cut piece of nailing strip) should be installed inside the j-trim (#605) or Siding J Color (#610) to protect the cut edge of the panel. If the panel terminates on the intermediate portion of a batten, it may be necessary to build up behind it with a furring strip.



PARTS LIST

- #605 - J Trim
- #610 - Siding J Color
- #620 - Siding Snap Lock

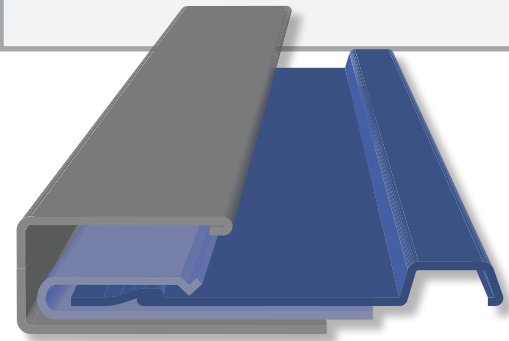

OUTSIDE CORNERS

Outside corners should be installed after fastening any panels, as their nailing flange is hidden behind the finishing wall panels. They require the use of a siding outside corner cleat (#630) with a siding outside corner (#625) snapped over that.

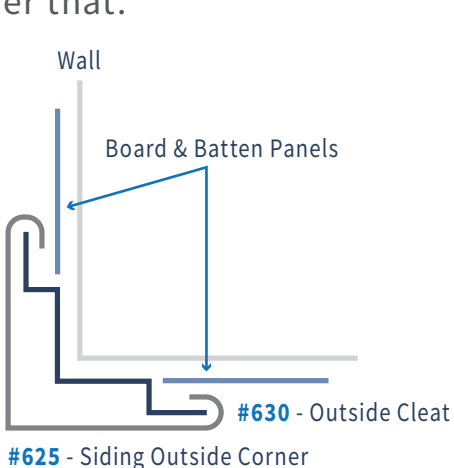

PARTS LIST

- #625 - Siding Outside Corner
- #630 - Outside Cleat



INSIDE CORNERS

There are 2 different ways to install an inside corner. One way is to run your panels into a siding double J (#600).

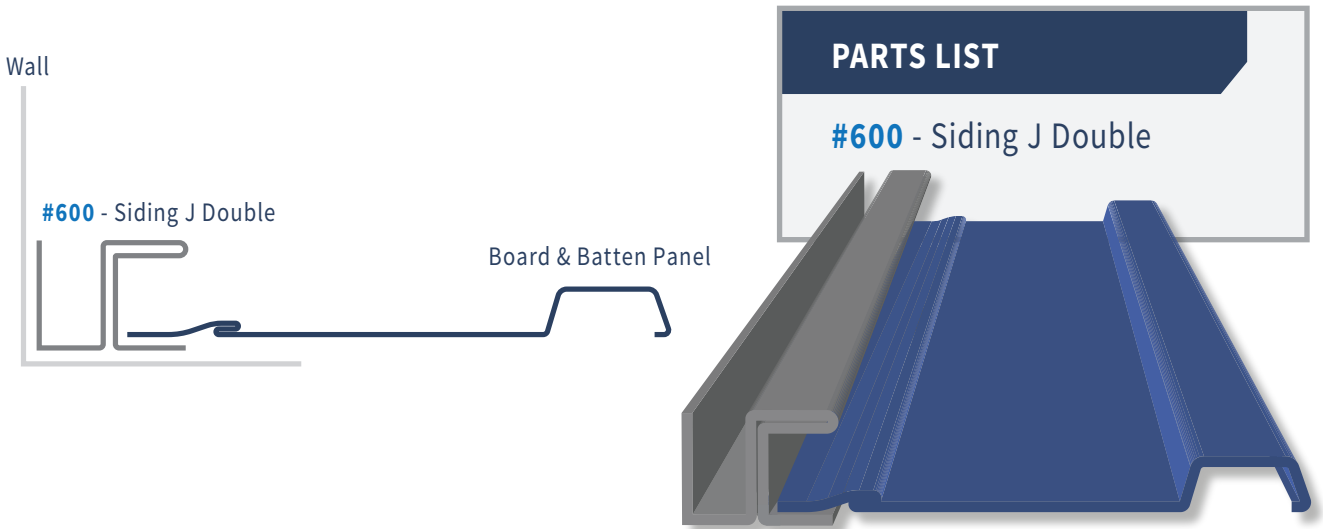

The other way is before fastening panels, use an inside corner cleat (#631) with a siding inside corner (#626) snapped over that.

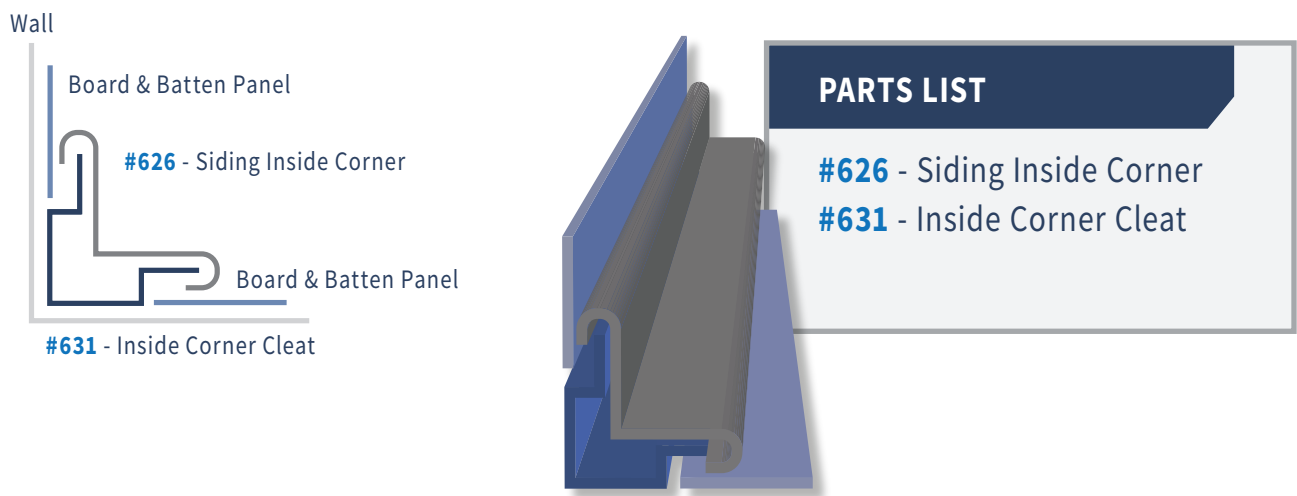

PANEL TRANSITION

In some circumstances, it may be desired or necessary to make a horizontal break or transition within the wall panels. This is frequently done where a gable begins.



For a bolder look use a siding transition trim #650. Put your gable metal panels down first then place the siding transition next and finish the rest of your wall.

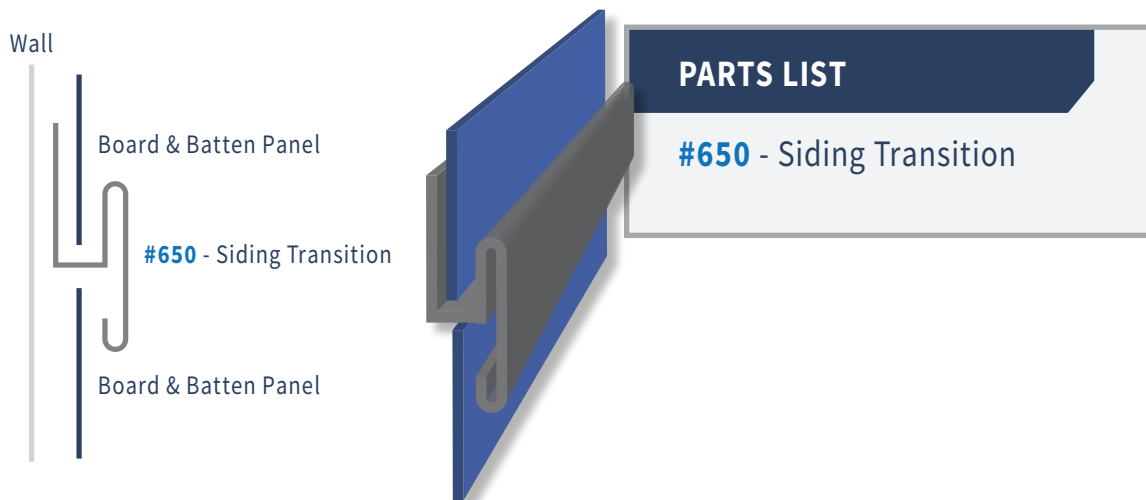

If you like something more inconspicuous, use z-bar trim in its place.

DRIP FLASHING (FOR ROCK OR BRICK)

Drip Flashing (#660) is custom due to the depths of products being used and your counter flashing being used. Stone may protrude out further than brick so the depth of trim needed will vary. Here depicts an example of a flashing to be used.



For a bolder look use a siding transition trim #650. Put your dripflashing down first then place the metal panels next and finish the rest of your wall.



If you like something more inconspicuous, use z-bar trim in its place.

COLONIAL 5" & DOUBLE 5" DUTCH

COLONIAL 5" SIDEVIEW

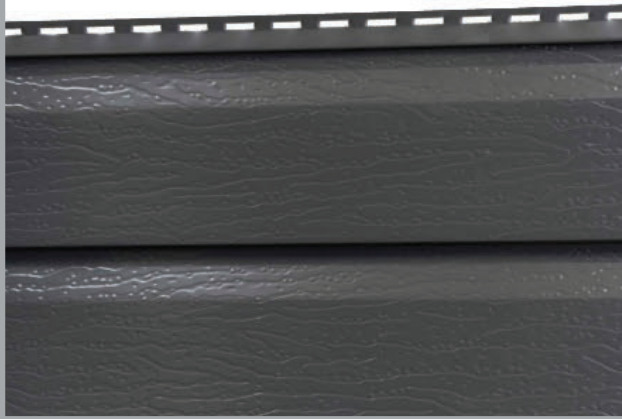

DOUBLE 5" DUTCH SIDEVIEW



Both Colonial 5" and Double 5" Dutch metal gives the appearance of vinyl siding with the durability of steel. With custom lengths from 1' to 70,' it creates a seamless look without laps like vinyl.

Panel Specifications:

- The style of wooden siding with the durability of steel
- 45-year limited lifetime warranty
- Hidden fastener system
- Custom sizing 1' to 70' length
- 26 GA

FASTENING PANELS

When installing Colonial 5" and Double 5" Dutch panels, be sure to use our ultra-low pancake fasteners. Never overtighten fasteners so that the panels are able to move against the substrate. Fasteners must be driven in straight, not at an angle. Colonial 5" and Double 5" Dutch should be installed over a minimum 7/16" OSB substrate. Fasteners will need to be installed every 12".

INSTALLING PANELS

Colonial 5" or Double 5" Dutch ends will need to be covered using a siding double j (#600) due to imperfections from the cut. Keep that in mind when selecting trim to be sure that ends are hidden in the proper trim. Before installing panels be sure to install your siding starter strip (#615) (see below), door trim (#610 or #605), window trim (#610 or #605), siding inside corner cleat (#631), siding double j (#600), drip flashing (#660) and top finish strip (#640), Outside Corner Cleat (#625).

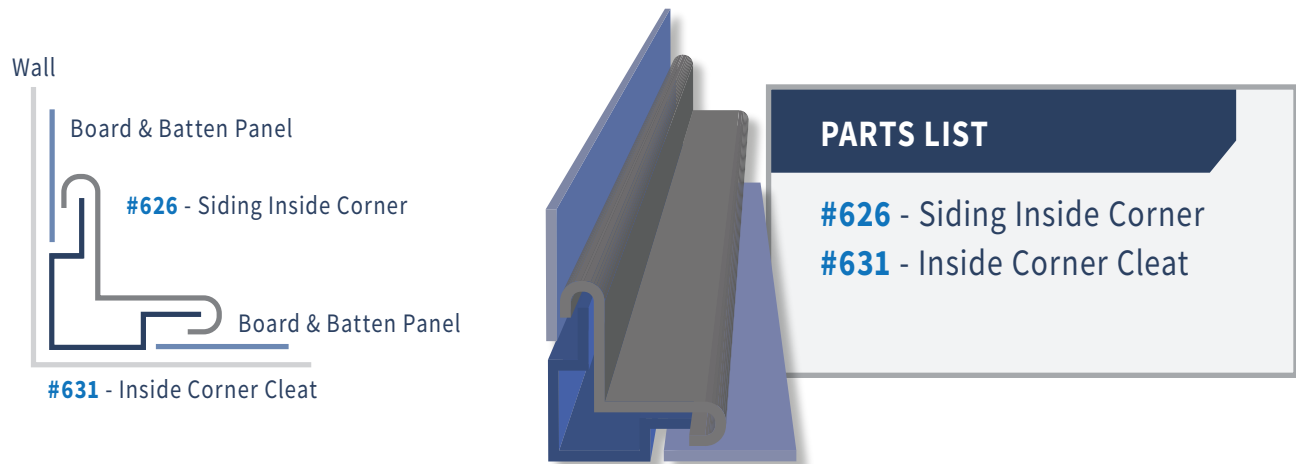

When you install your starter strip (#615) making sure it's level and goes around the perimeter of your house. If your house requires addition flashing one of the following trim pieces maybe required. Rat guard (#171), Drip flashing (#660) or Siding transitions trim (#650).



INSTALLING PANELS (CONT'D)

Slide your Colonial 5" or Double 5" Dutch into your starter strip and stop. Make sure the panel is level and fasten down with your ultra-low profile pancake screws. Continue to go up your wall in the same manner until you reach the top. You may need to rip a panel to fit the last row. Slide your panel into the siding snap lock (#620), or place snap lock (#620) into your siding double j trim (#600), or a top finish strip (#640).

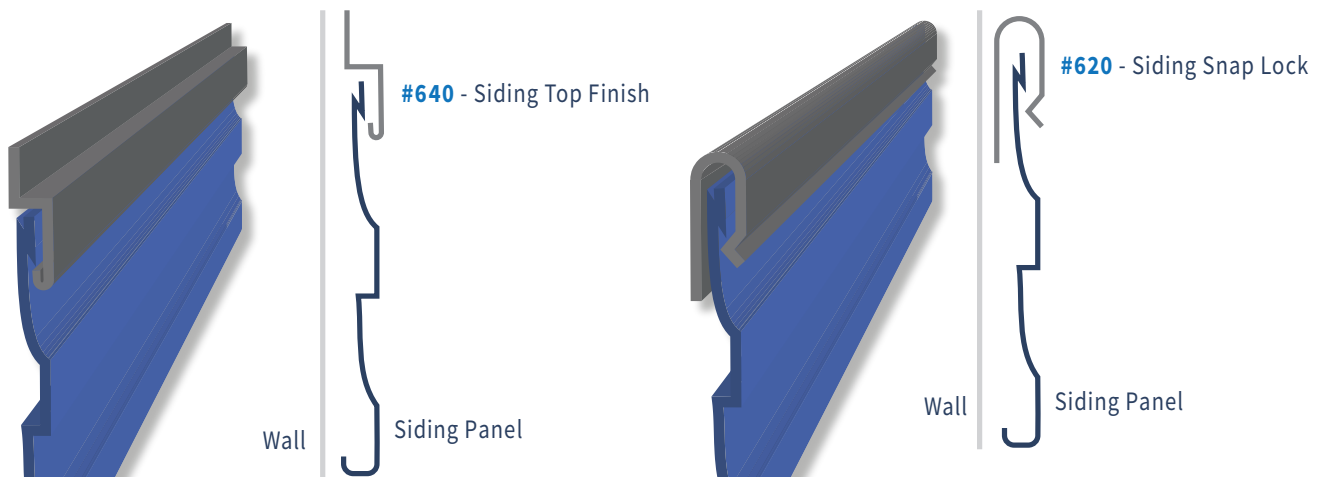

PARTS LIST

#640 - Siding Top Finish

PARTS LIST

#620 - Siding Snap Lock

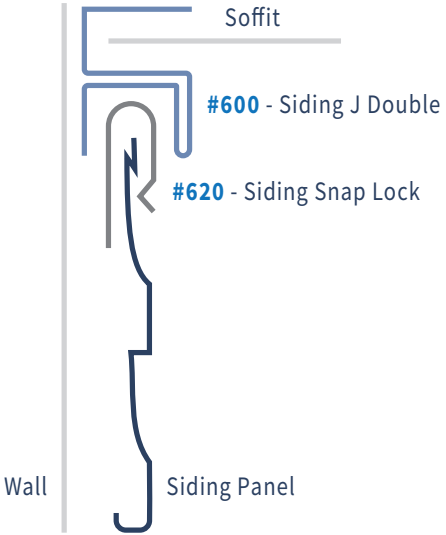

PARTS LIST

#600 - Siding J Double
#620 - Siding Snap Lock

DOORS, WINDOWS AND OTHER OPENINGS

When the panel butts against the side of a window or door opening they will need to be tucked into the j-trim (#605) or Siding J Color (#610) to hide the cut edge of the panel.

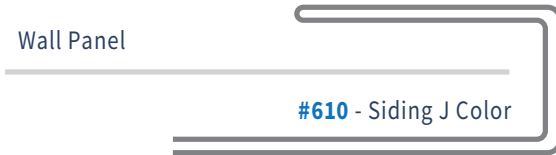

PARTS LIST

- #605 - J Trim
- #610 - Siding J Color

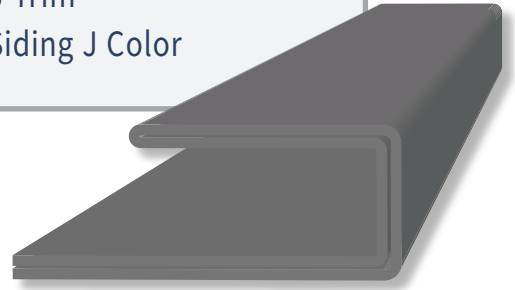

OUTSIDE CORNERS

Our outside corner is comprised of two pieces. The outside cleat (#630), and the outside corner (#625) to create a concealed fastener finished product.

#630 - Outside Cleat

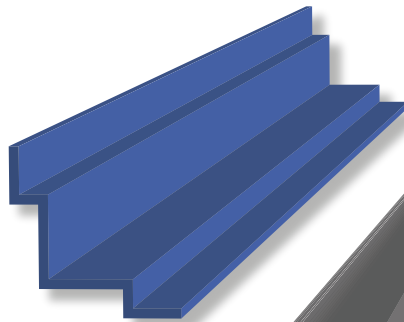

#625 - Siding Outside Corner

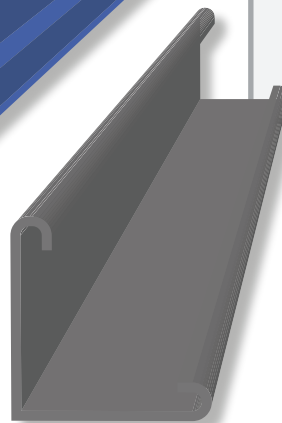
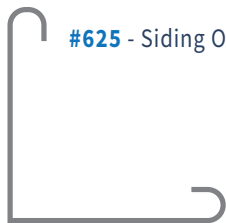

PARTS LIST

- #630 - Outside Cleat
- #625 - Siding Outside Corner

OUTSIDE CORNERS (CONT'D)

Install your wall panels then use a siding outside corner cleat (#630) with a siding outside corner (#625) snapped over that.

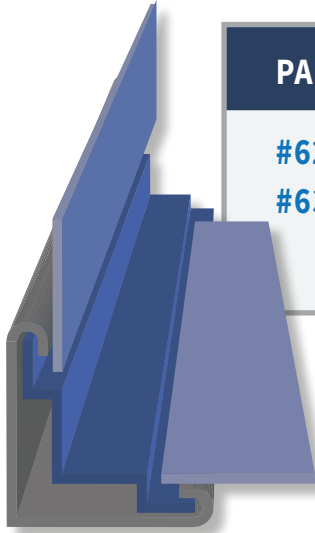
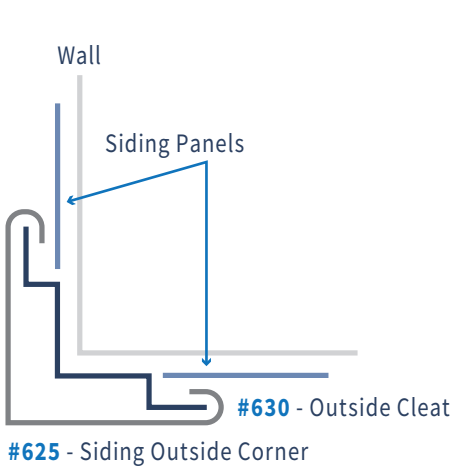

PARTS LIST

- #625 - Siding Outside Corner
- #630 - Outside Cleat

INSIDE CORNERS

There are 2 different ways to install an inside corner.

- 1) Run your panels into a siding double J (#600).

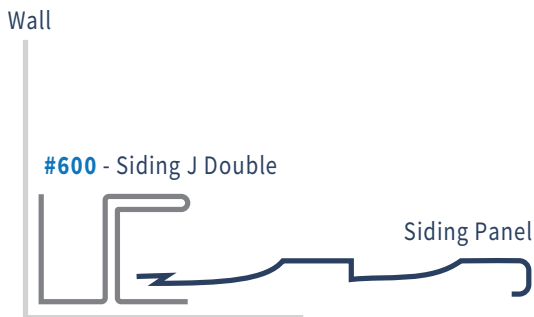

INSIDE CORNERS (CONT'D)

- 2) Before fastening panels:
 - a. use an inside corner cleat (#631)
 - b. install wall panels
 - c. Snap the siding inside corner (#626) over the inside corner cleat.

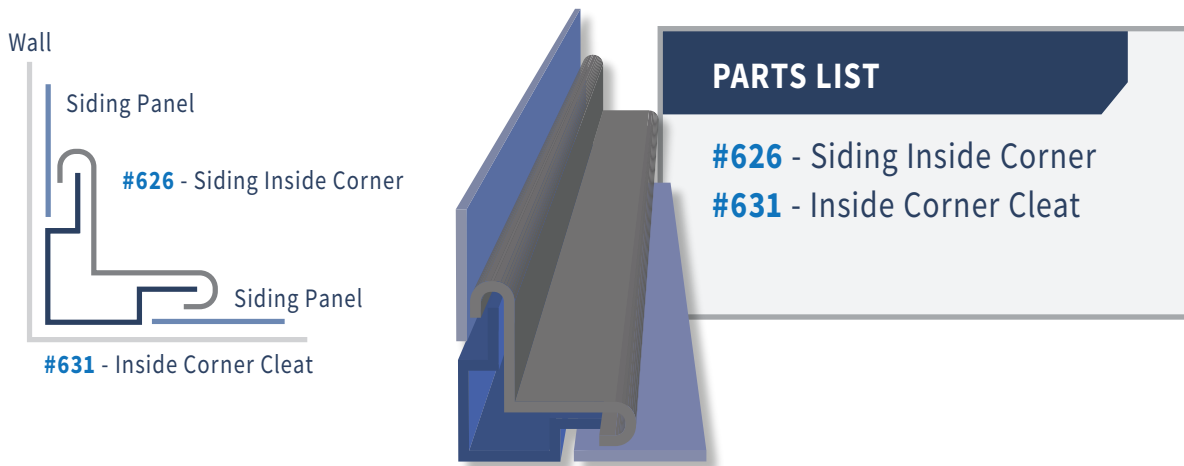

PANEL TRANSITION

In some circumstances, it may be desired or necessary to make a horizontal break or transition within the wall panels. This is frequently done where a gable begins. For a bolder look use a siding transition trim #650. Put your gable metal panels down first then place the siding transition next and finish the rest of your wall.

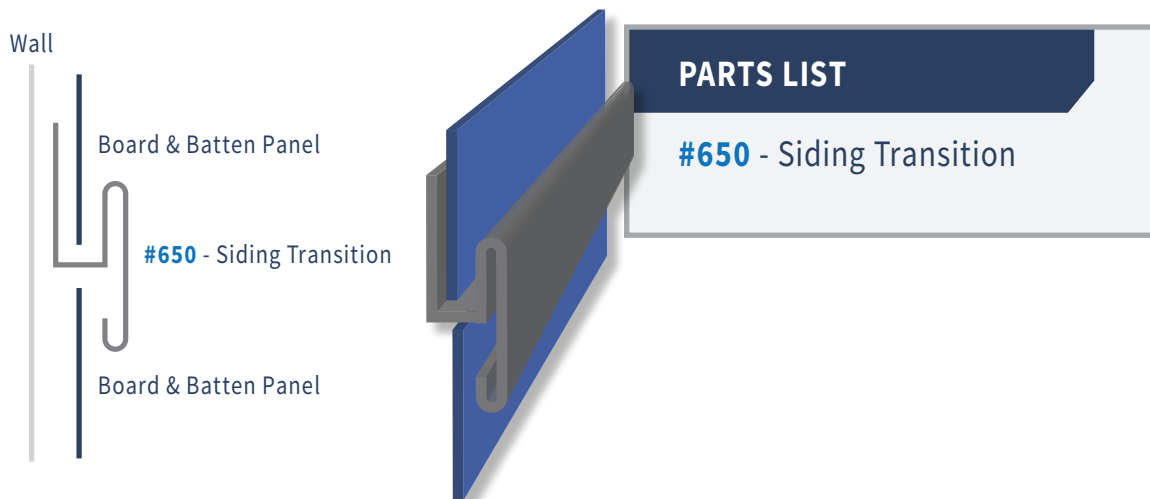

SIDING TRIM PROFILES

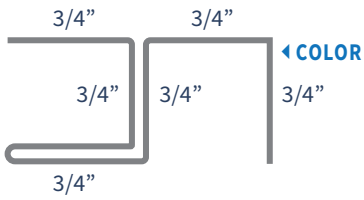

PART
#600 - Siding J Double

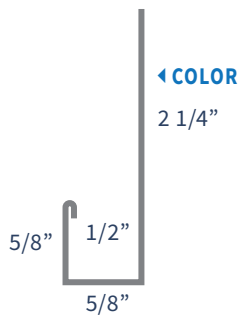
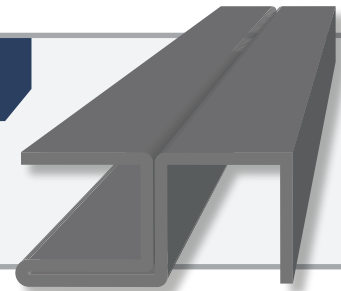

PART
#605 - Siding J

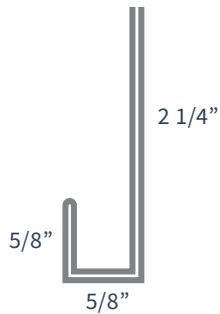
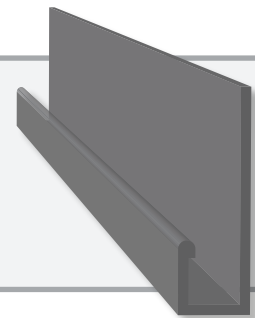

PART
#610 - Siding J Color

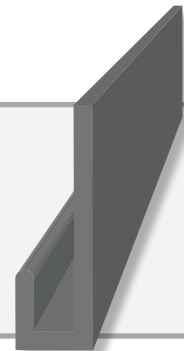

PART
#615 - Siding Starter Strip

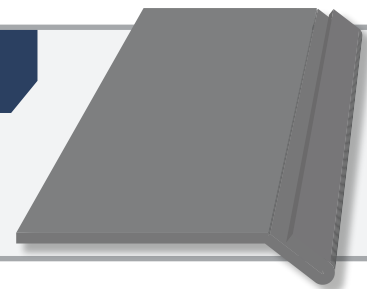

SIDING TRIM PROFILES

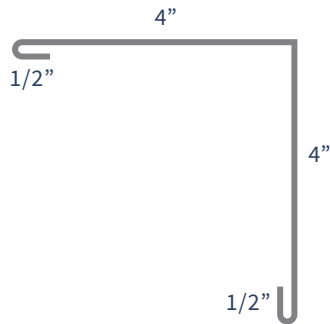

PART

#625 - Siding Outside Corner
(must have outside cleate #630)

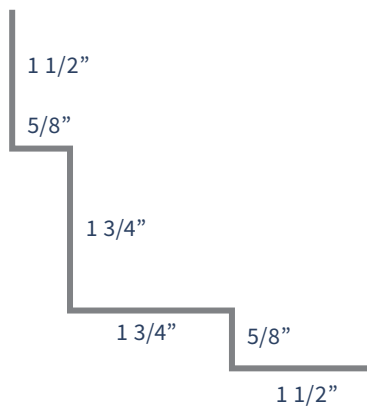
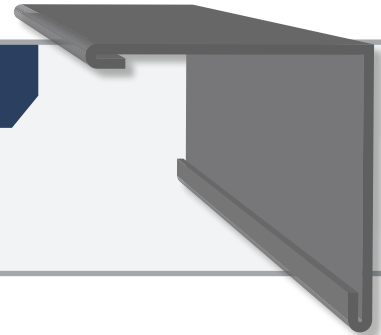

PART

#630 - Siding Outside Cleate
(must have outside corner #625)

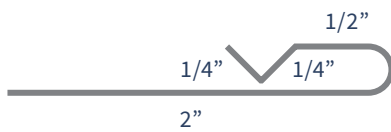

PART

#620 - Siding Snap Lock

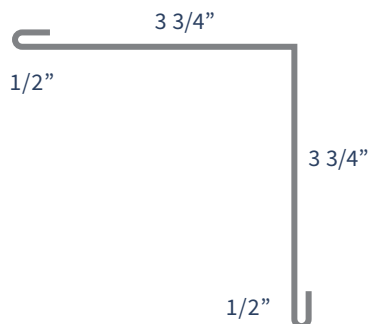
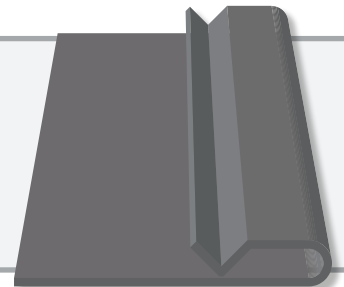

PART

#626 - Siding Inside Corner
(must have inside corner cleate #631)



SIDING TRIM PROFILES

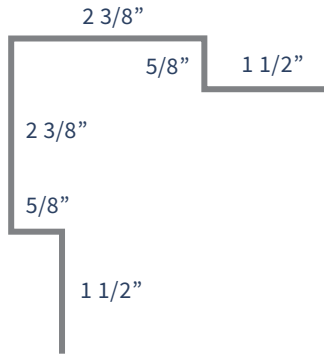

PART

#631 - Siding Inside Corner Cleat
(must have inside corner cleat #626)

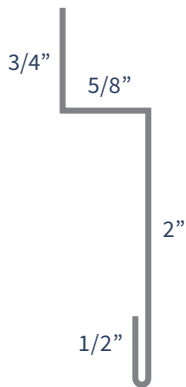
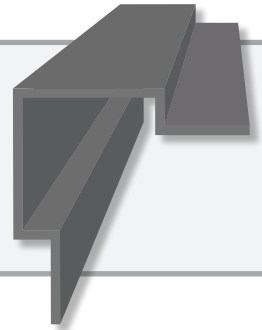

PART

#640 - Siding Top Finish Strip

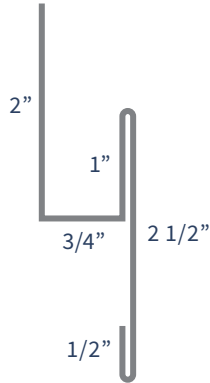

PART

#650 - Siding Transition

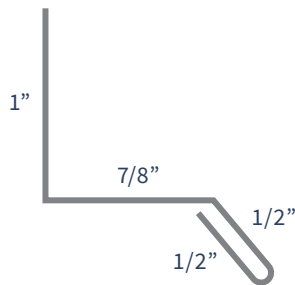

PART

#660 - Drip Flashing

